

Automatic frame slicers

FACE+

- ✓ Depth reduced to minimise space requirements
- ✓ Maximum safety thanks to the rear cover actuating the cutting process
- ✓ Removable, ergonomic crumb collector
- ✓ Automatic cutting cycle for simplicity in use and optimum time management
- ✓ Silent

Up to 250 loaves an hour

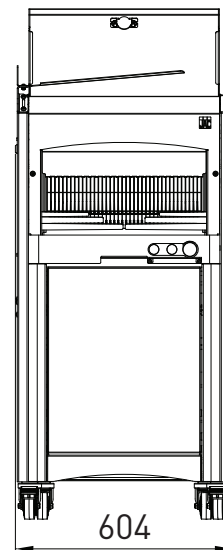
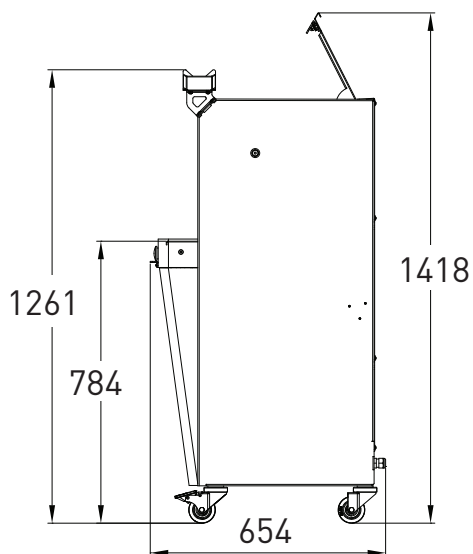

Traditionally Innovative

www.jac-machines.com

info@jac-machines.com



Intelligent Slicing Concept (JAC patent)

Continuous automatic control system that slices loaves according to their consistency. This allows open textured, crusty and dense breads to be sliced with equal efficiency.



Loaf pusher pressure selector

Allows working at low, high or automatically adjusted pressure (ISC).



Rear safety cover

Closing it initiates the slicing process and it opens automatically when slicing is complete.

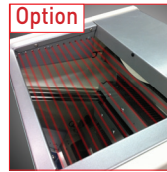

Safety light barrier

Increased accessibility while maintaining an optimum safety level.



Removable crumb collector

Accessible by tilting the front, cylinder-assisted door. 18 litre capacity.



Daily adding counter

Tells the user how many loaves have been cut for maintenance interval monitoring purposes.



Type available "M" system

Micronised knife lubrication system for cutting bread with a high rye content or sticky crumb. Developed by JAC, it consumes the least possible amount of oil (120 ml per 1000 loaves) and delivers consistent cutting quality.

FEATURES

	FACE+ 450	FACE+ 450M 
Max. loaf dimensions in cm (L x W x H)	44 x 31 x 16	44 x 30 x 16
Motor power in kW	0.49	1.1
Net weight (in kg)	155	160
Blade type and dimensions in mm	13 x 0.5 steel	13 x 0.5 Teflon coated
Daily adding counter		•

CHOICES

Slice thickness in mm	9 - 18	9 - 12
Loaf pusher height	Extra low (50mm) Low (80mm) High (100mm)	Misch (80mm)
Type of motor	230V single phase 230V three-phase 400V three-phase	400V three-phase
Standard colour*	•	•

OPTIONS

Heavy duty motor	•	
Safety light barrier	•	•
4 cm height adjustment	•	•
Loaf pusher pressure selector	•	•
Daily adding counter	•	
Double slice thickness	•	
Special colour	•	•
Special blades	•	

*STANDARD COLOURS

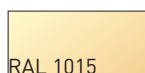

RAL 1015

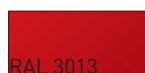

RAL 3013



RAL 9005

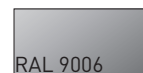

RAL 9006

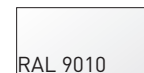

RAL 9010