

## Self-service frame slicers

# NEW SELF

- ✓ Maximum safety due to the double cover being locked during the cutting cycle
- ✓ Removable, ergonomic crumb collector
- ✓ Automatic cutting cycle for simplicity of use
- ✓ Easy users guide
- ✓ Front bumper to protect the machine

Up to 250 loaves an hour

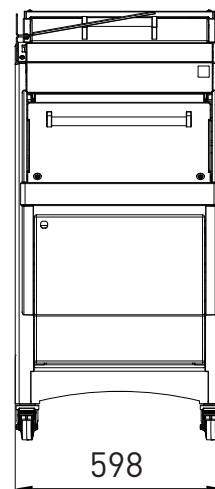
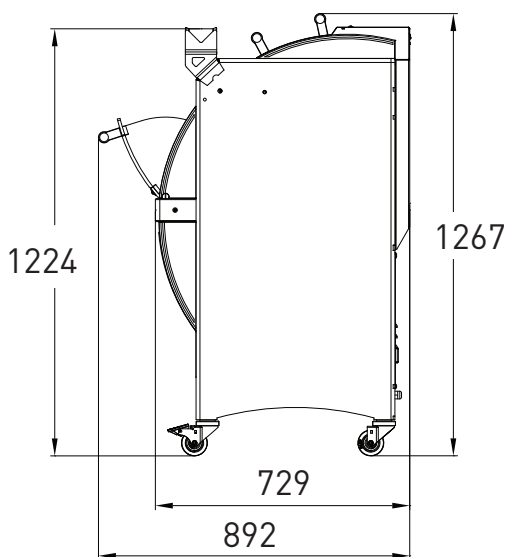



### Intelligent Slicing Concept (JAC patent)

Continuous automatic control system that slices loaves according to their consistency. This allows open textured, crusty and dense breads to be sliced with equal efficiency.



### JAC FIX

Holds the loaf together for easier handling at the exit of the slicer.



### Front safety cover

Locked during the slicing process for maximum safety.



### Removable crumb collector

Completely safe. Accessible by tilting the front door. 25 litre capacity.



### Rear safety cover

Closing it initiates the slicing process and it remains mechanically and electrically locked during cutting.



### Option

### JAC STOP (JAC patent)

This patented system holds the bread slices together to facilitate handling.

Option suited to specific types of bread: contact JAC for details.



### Type available "M" system

Micronised knife lubrication system for cutting bread with a high rye content or sticky crumb. Developed by JAC, it consumes the least possible amount of oil (120 ml per 1000 loaves) and delivers consistent cutting quality.

## FEATURES

	NEW SELF 450	NEW SELF 450M 
Max. loaf dimensions in cm (L x W x H)	44 x 31 x 16	44 x 30 x 16
Motor power in kW	0.49	1.1
Net weight (in kg)	210	220
Blade type and dimensions in mm	Steel 13 x 0.5	13 x 0.5, Teflon-coated
JAC FIX	•	•

## CHOICES

Slice thickness in mm	9 - 18	9 - 12
Loaf pusher height	Extra low (50mm) Low (80mm) High (100m)	Misch (80mm)
Type of motor	230V single phase 230V three-phase 400V three-phase	400V three-phase
Standard colour*	•	•

## OPTIONS

Heavy duty motor	•	
JAC STOP	•	•
Extra 4 cm height	•	•
Users explanatory notice	•	•
Daily adding counter	•	•
Special colour	•	•
Special blades	•	

### Option

#### self service

Tranchez votre pain vous-même, facilement et en toute sécurité.



Contactez-nous pour plus d'informations.

### Users explanatory notice

### \*STANDARD COLOURS

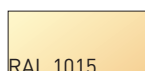

RAL 1015

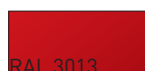

RAL 3013



RAL 9005

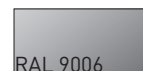

RAL 9006

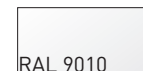

RAL 9010